

WISENET

NETWORK VIDEO DECODER

Quick Guide

SPD-152

CE







Features

This product monitors the video and sound of the network camera. The PC provides an environment where this product can be set up.

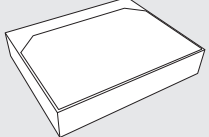
- Provides new UI 2.0
- Play Layout Sequence
- Supports thermal imaging camera/PTZ linked camera
- Supports a range of 4K camera resolutions
- Outputs a 4K high definition image using HDMI
- Supports dual monitor output (expand, duplicate)
- Supports ONVIF Profile S standard and RTP / RTSP protocols
- Simultaneous play of 64 channels
- Live monitoring of the network camera
- Installation Wizard Function (Recorder, Web Viewer)

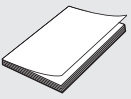
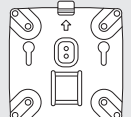
Package Contents

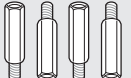
Please unwrap the product, and place the product on a flat place or in the place to be installed. Please check the following contents are included in addition to the main unit.

		
Decoder	Mouse	Quick Guide
		
Multi-adapter	Terminal block	M4 L20 stud (for VESA hole, 4 ea)
		
M4 L8 screw (for multi-adapter, 4 ea)	M3 L6 screw (for decoder base hole, 2 ea)	

CAUTION

- RISK OF EXPLOSION IF BATTERY IS REPLACED BY AN INCORRECT TYPE. DISPOSE OF USED BATTERIES ACCORDING TO THE INSTRUCTIONS.
- Do not ingest battery, Chemical Burn Hazard.
- This product contains a coin / button cell battery. If the coin / button cell battery is swallowed, it can cause severe internal burns in just 2 hours and can lead to death.
- Keep new and used batteries away from children. If the battery compartment does not close securely, stop using the product and keep it away from children. If you think batteries might have been swallowed or placed inside any part or the body, seek immediate medical attention.

ATTENTION

- IL Y A RISQUE D'EXPLOSION SI LA BATTERIE EST REMPLACÉE PAR UNE BATTERIE DE TYPE INCORRECT. METTRE AU REBUT LES BATTERIES USAGÉES CONFORMÉMENT AUX INSTRUCTIONS.
- Ne pas ingérer la pile, risque de brûlure chimique.
- Ce produit contient une pile de type bouton/pièce de monnaie. Si la pile de type bouton/pièce de monnaie est avalée, elle peut causer de graves brûlures internes en seulement 2 heures et peut entraîner la mort.
- Gardez les piles neuves et usagées hors de portée des enfants. Si le compartiment de la pile ne se ferme pas correctement, cessez d'utiliser le produit et gardez-le d'atteinte des enfants. Si vous suspectez que des piles ont été avalées ou insérées dans une partie du corps, consultez un médecin sans tarder.

Installation

Please take note of the followings before using this product.

- Do not use the product outdoor.
- Do not spill water or liquid in the connection part of the product.
- Do not impose the system to excessive shock or force.
- Do not pull out the power plug forcefully.
- Do not disassemble the product on your own.
- Do not exceed the rated input/output range.
- Use a certified power cord only.
- For the product with an input ground, use a grounded power plug.

Mounting the Multi Adapter

You can mount a decoder on the monitor's VESA holes or a pole using a multi-adapter. The multi-adapter supports the following VESA standards.

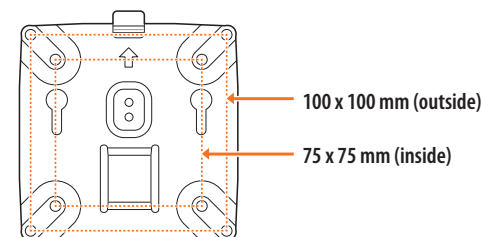

Mounting on the Monitor's VESA Holes

1. Fix the multi-adapter to the monitor by using four M4 L8 screws.



- Confirm the monitor on which you intend to mount the multi-adapter meets the VESA standards.

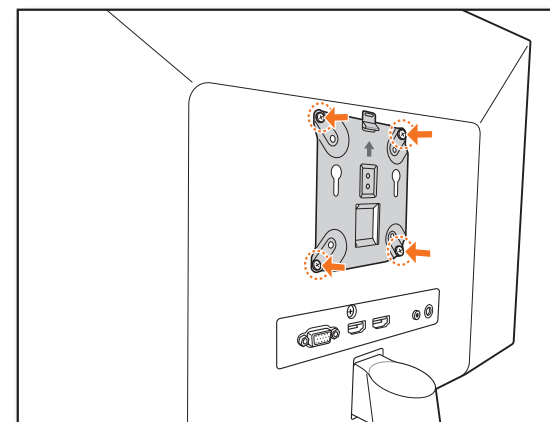

2. Fasten two M3 L6 screws to the base of the decoder.

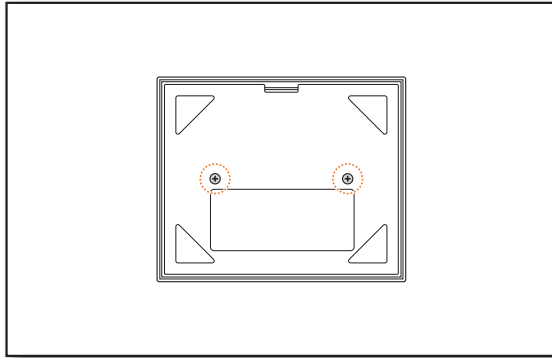

3. Make sure the screws on the base of the decoder go into the threaded holes of the multi-adapter.

- Mount the decoder with the connecting terminal facing down.

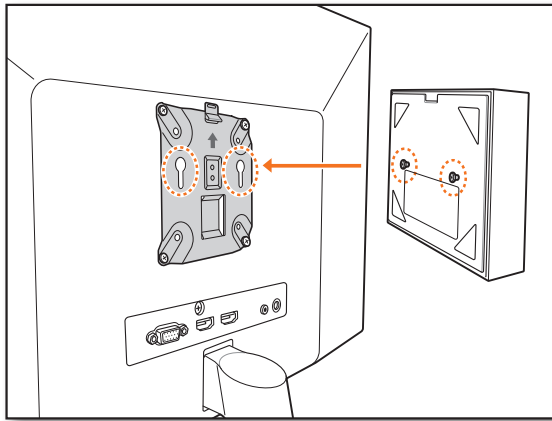

4. Press the decoder toward the monitor and then slide it down to fix it.

- Press the decoder until the metal spring of the multi-adapter is exposed and fix the decoder.

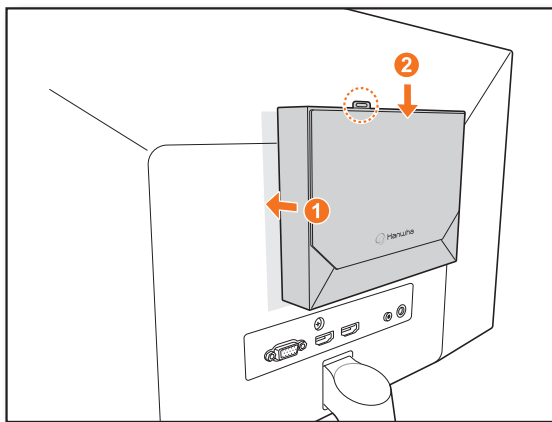

Disconnecting the Multi-adapter

Lift the decoder while pressing the multi-adapter's metal spring.

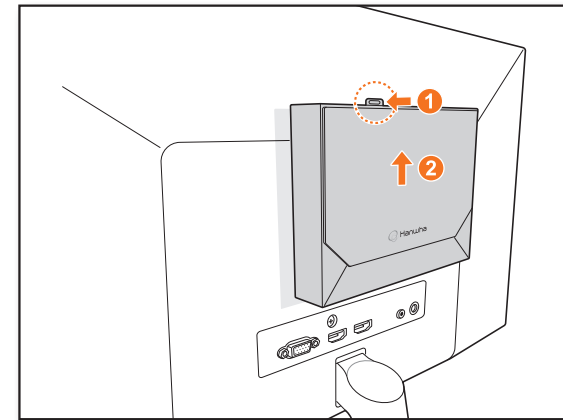

Mounting with Stud Screws

If it is not possible to mount the decoder on the monitor because the monitor's VESA holes are too close to the monitor's connecting terminal or stand, you can use stud screws to mount the decoder.

Fasten four M4 L20 stud screws in the VESA holes on the back of the monitor, and mount the multi-adapter.

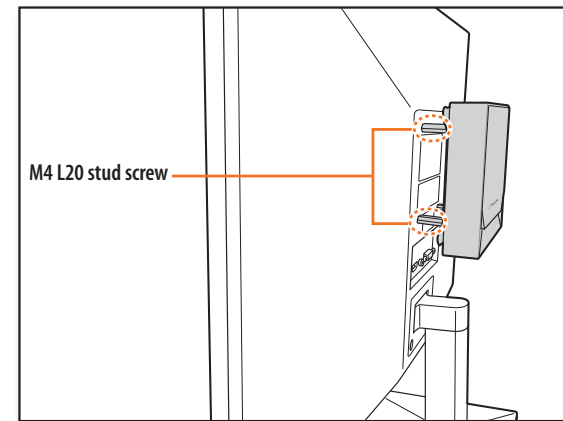

Mounting on a Pole

1. Mount the multi-adapter on the pole using a strap.

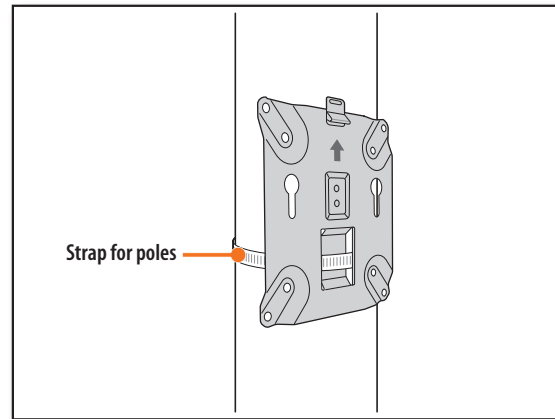

2. Fasten two M3 L6 screws on the base of the decoder and mount the decoder to the multi-adapter.

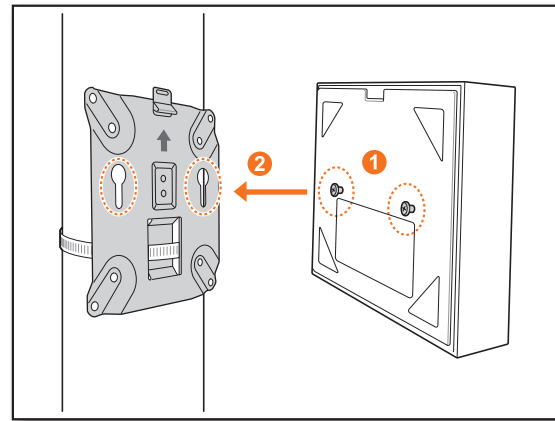

-  ■ The strap for poles (SBP-100S) is sold separately.

Connecting to an External Device

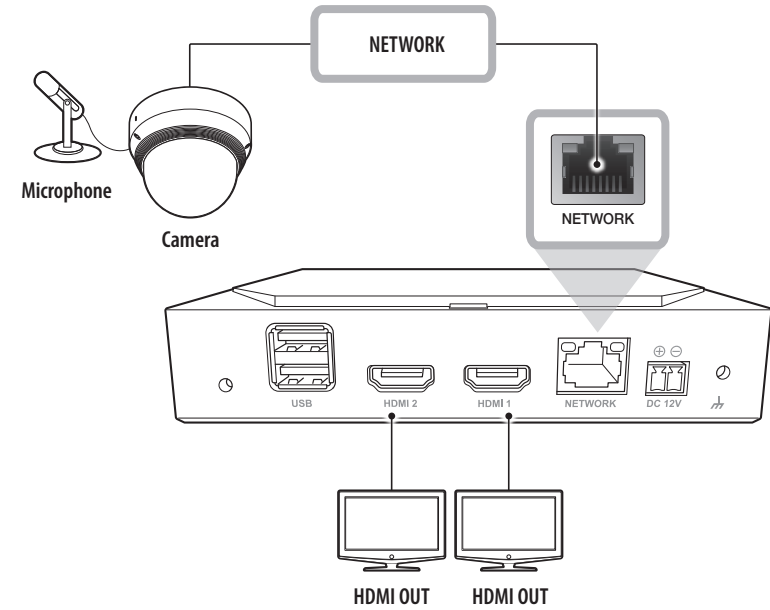

-  ■ Ensure that you use only a rated power source before connecting power to the system.

Connecting to a Network Using a Router

If you want to add 1-3 PCs and decoders to an environment using an xDSL/Cable modem, you can use a router with only one Internet line.

This guide is an installation guide for network beginners. Follow the instructions to set up your router, local PC, and decoder.

Connecting the cable

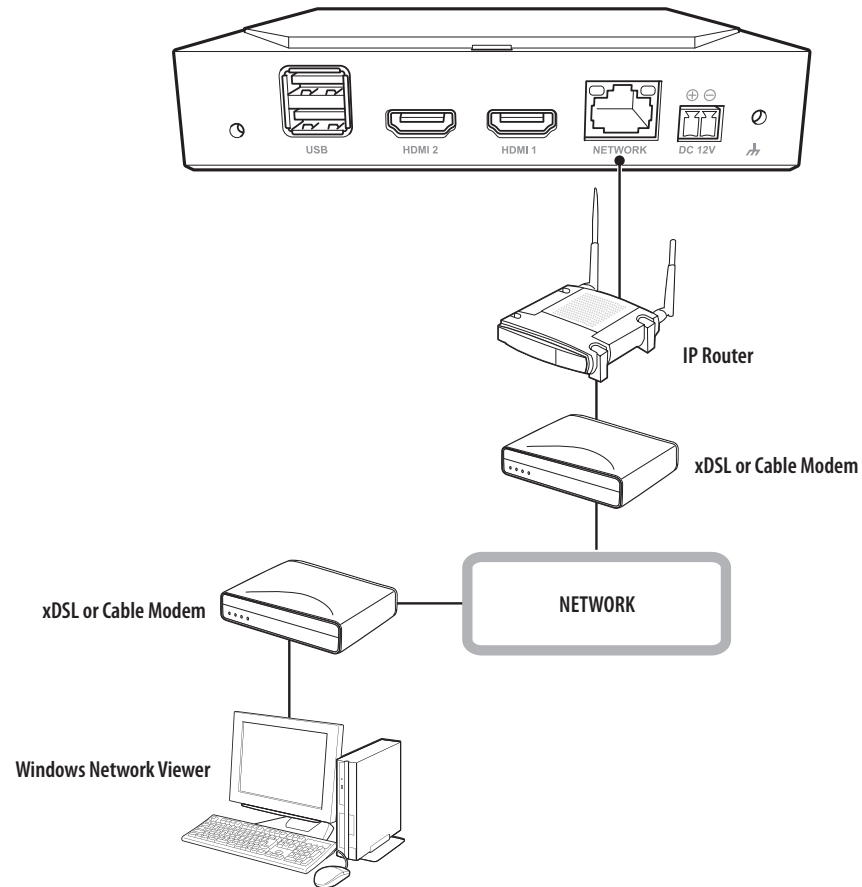

Connecting the PC and Router

 ■ Refer to the router's user manual.

Connecting the Decoder and Router

Move to the <IP & Port> of the decoder <Network> Setting menu, and set the **1**<IP address> and **2**<Gateway> in <Setup>.

※ The <Default gateway> checked in the [cmd.exe] window of the Local PC and the <Gateway> of the decoder must be the same.

※ The first three numbers of the decoder <IP address> should match the first three of the <Default gateway> checked in the [cmd.exe] window of the local PC.

```
Microsoft Windows [Version 10.0.18362.329]
(c) 2019 Microsoft Corporation. All rights reserved.

C:\Users\User> ipconfig

Windows IP Configuration

Ethernet adapter Ethernet 2:

    Connection-specific DNS Suffix  . : kornet
    IPv4 Address. . . . . : 192.168.219.192
    Subnet mask . . . . . : 255.255.255.0
    Default Gateway . . . . . : 192.168.219.1

C:\Users\User>
```

<cmd screen>

Network2

IPv4

IP type: Manual

1 IP address: 192.168.219.192

2 Subnet mask: 255.255.255.0

Gateway: 192.168.219.1

DNS: Manual 168.126.63.1

IPv6

Enable IPv6:

IP type: Default DHCP Manual

IPv6 Address: / 64

DNS: Auto

Ok Cancel

<Decoder screen example>

Using Product Information

You can check the product information/manual/firmware information/FAQ/HDD compatibility list on the homepage or mobile web of your smartphone.

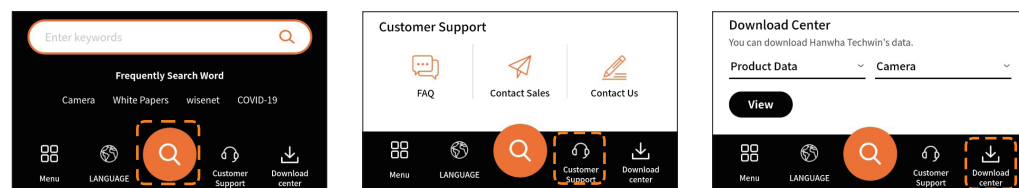
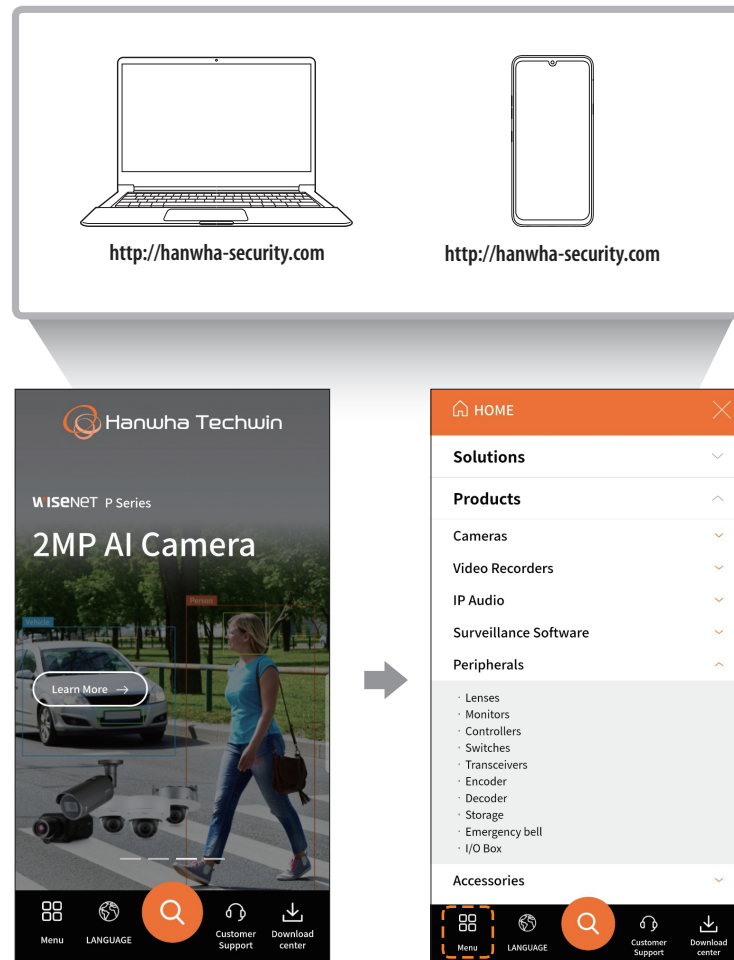



Hanwha Techwin cares for the environment at all product manufacturing stages, and is taking measures to provide customers with more environmentally friendly products. The Eco mark represents Hanwha Techwin's devotion to creating environmentally friendly products, and indicates that the product satisfies the EU RoHS Directive.



Correct Disposal of This Product (Waste Electrical & Electronic Equipment)

(Applicable in the European Union and other European countries with separate collection systems)

This marking on the product, accessories or literature indicates that the product and its electronic accessories (e.g. charger, headset, USB cable) should not be disposed of with other household waste at the end of their working life. To prevent possible harm to the environment or human health from uncontrolled waste disposal, please separate these items from other types of waste and recycle them responsibly to promote the sustainable reuse of material resources.

Household users should contact either the retailer where they purchased this product, or their local government office, for details of where and how they can take these items for environmentally safe recycling.

Business users should contact their supplier and check the terms and conditions of the purchase contract. This product and its electronic accessories should not be mixed with other commercial wastes for disposal.



Correct disposal of batteries in this product

(Applicable in the European Union and other European countries with separate battery return systems.)

This marking on the battery, manual or packaging indicates that the batteries in this product should not be disposed of with other household waste at the end of their working life. Where marked, the chemical symbols Hg, Cd or Pb indicate that the battery contains mercury, cadmium or lead above the reference levels in EC Directive 2006/66. If batteries are not properly disposed of, these substances can cause harm to human health or the environment.

To protect natural resources and to promote material reuse, please separate batteries from other types of waste and recycle them through your local, free battery return system.



Hanwha
Techwin